

EUROPAIR 

CONTROL THE AIR YOU BREATHE

DUCTLOK FLANGING & FASTENERS

technical

Europair Africa

a division of Performancair Products Africa (Pty) Ltd

tel +27 11 974 2425
fax +27 11 974 2443
web www.europair-africa.com
email: info@europair-africa.com

Cnr. Grader and Vuurslag
Spartan Ext. 3
Kempton Park
Johannesburg

FLEXIBLE DUCTING

THE TOTAL DUCT FLANGE SYSTEM

DUCTLOK FLANGE

A roll formed galvanized steel angle incorporating a permanent non hardening sealant, which guarantees a dependable air tight connection - eliminates the need for post installation sealing of the duct.

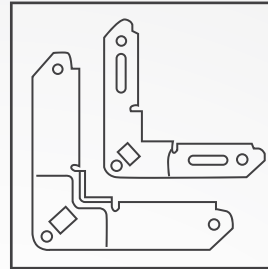
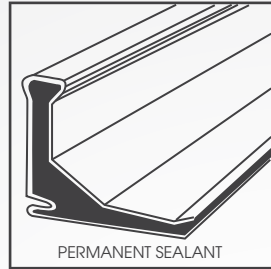

CORNER PIECE

The Ductlok corner piece is ribbed and edged flanged for extra rigidity and features an embossed dimple ensuring an extra tight corner joint. The bolt hole is suitable for carriage type or normal bolt corners, available in 2 sizes; Junior and Senior.

REINFORCEMENT BEAD

The unique DUCTLOK REFORCEMENT bead makes the flange stronger than conventional flanges, thereby reducing the necessity for many different gauges of flange profiles. DUCTLOK produces only 2 sizes to cover all applications. (DUCTLOK JUNIOR - 25mm x 0.8mm, DUCTLOK SENIOR - 35mm x 1.00mm).

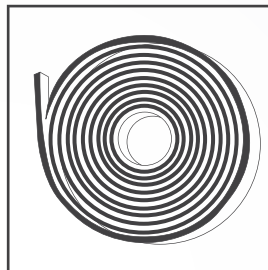
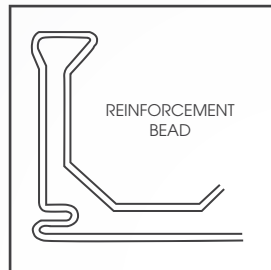

GASKET TAPE

A Butyl rubber sealant strip for insertion between Ductlok flanges. Easily installed. The tape is water, heat and UV resistant.

JOINING CLAMP

Ductlok Bolt-on flange clamp for clamping of duct flange joints.

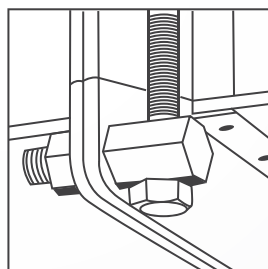
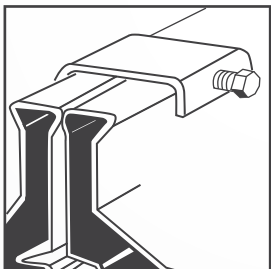

HANGER BOLT

The Ductlok Hanger Bolt is a new concept in reducing your duct hanging costs. When fitted to the Ductlok corner piece in place of a normal or carriage bolt, a length of threaded duct hanging rod can be fitted through the hanger bolt, thus permitting the duct hanger to be fixed to the corner piece.

Assembly and installation data:

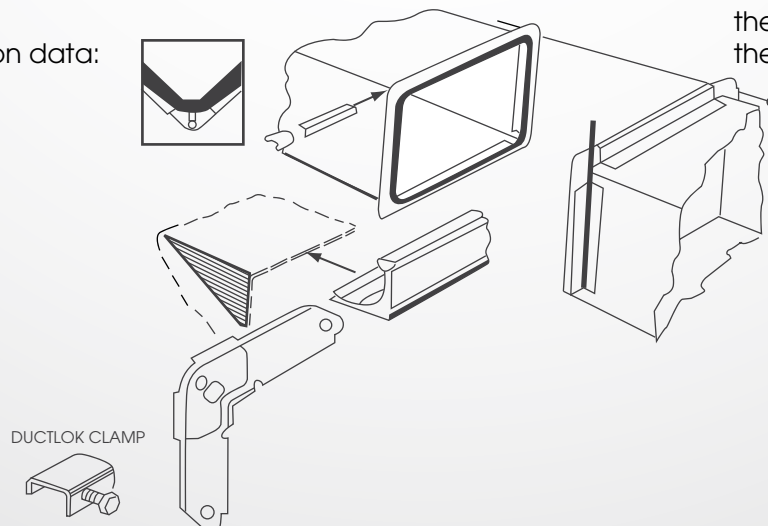

Assembly and installation data: (continued)

CODE	DUCTLOK	QTY
1510025	Junior flange (25mm)	5 metre
1510035	Senior flange	5 metre
1520025	Junior Corner	100
1520035	Senior Corner	100
1530200	Ductlok Clamp	100

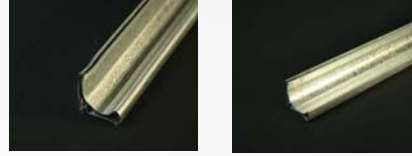

CODE	DUCTLOK	QTY
1530320	Gasketing (5mm)	10 metre
1530306	Eurostick Gasket (6mm)	60 metre
1532900	Ductlok Hanger Bolt	10

CODE	DUCTLOK	QTY
502012	Bar Cleat (reinforced cleat)	2400 mm
502047	Drive Cleat	2400 mm
503055	S Cleat	2400 mm

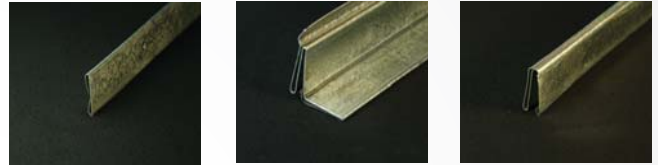

EUROPAIR is able to offer, effective and economical insulation fastening systems to meet your needs. These range from pins and washers, clip pins and hand held spotters, right through to automatic rolling and bulk feed pinspotters. The PN spotter pin and washer are used with the lightweight hand held LF2000 pin spotter - the industry standard. The CP clip pins with an integral nail washer are used with the MFPT, PBFS and other automatic pinspotters. CP clip pins by Duro Dyne have "lathe cut" points to ensure uniformly precise points and easy push through. Avoid imitations and settle for the leader.



CODE	LABEL	QTY
900019	PN 19 Weld pin	1000
900032	PN 32 Weld pin	1000
900050	PN 50 Weld pin	1000
900002	EC 2 Washer	1000
900119	PN 19/EC 2 set	1000 set
900132	PN 32/EC 2 set	1000 set
900150	PN 50/EC 2 set	1000 set
901028	CP 12 Clip pin	1000
901031	CP 34 Clip pin	1000
901040	CP 150 Clip pin	1000
400017	50 - Gripnail	1000
400025	100 - Gripnail	1000
401014	200 - Griphammer	each
902018	LF 2000	each
902059	MFPT	each
902000	PBF	each

